

# ALPHAFLO ECO-V 100

Energy Saving Variable Speed Pump

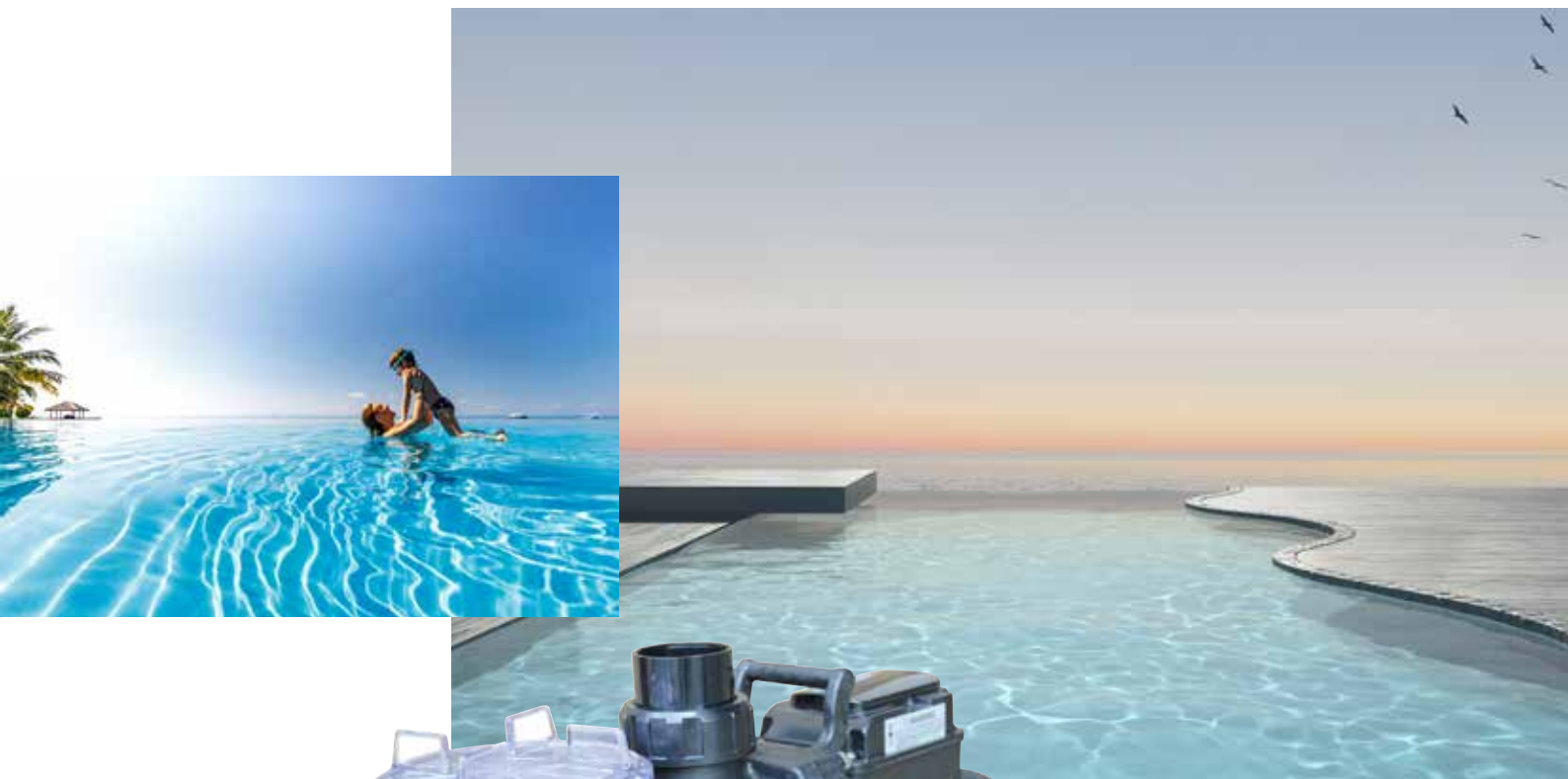

- Slash Energy Use By Up To 80%.
- Ultra Quiet Operation
- Enhanced Water Clarity.





# ALPHAFLO ECO-V 100

## Energy Saving Variable Speed Pump

The pump's impeller and diffuser design have been chosen carefully to help improve flow and efficiency by eliminating constrictions and obstacles maximises the hydraulic output of the pump while minimising turbulence.

The pump's hydraulic efficiency also comes from the design of the pump body that has improved water flow gaining performance outcomes that can shorten run times and reduces energy consumption leading to lower operating costs.

Plus a new heavy-duty pump bracket and insulation, which helps in absorbing motor vibration.

- Energy rating of 5 stars
- Excellent head & flow capabilities
- Variable permanent magnet brushless DC motor
- Ultra quiet operation

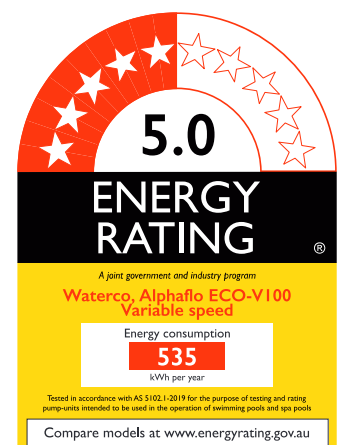

# SLASH ENERGY USE BY UP TO 80%.

## Energy Saving

A pool filtration system does not require to be operated at a pump's maximum water flow rate as with the use of a conventional pool pump limited to one speed. In fact, your pool's filtration efficiency improves at lower flow rates.

As a pool's filtration cycle occupies 99% of the run time of a pool pump, you can operate the Alphaflo ECO-V 100 on its low (ECO) speed setting for a majority of its running time, leading to a potential 80% savings in energy.

Equipped with the very latest variable speed permanent magnet brushless DC motor, Alphaflo ECO-V 100 is capable of lowering its motor speed, reducing water flow and lowering its energy consumption.



## Variable 3 Speed Options

Alphaflo ECO-V 100's variable 3 speed options cater for most pool functions.

### High speed

Vacuuming and backwash - 1% of the time

### Medium speed

Automatic pool cleaners

### Low speed

Filtration - 99% of the time

### Variable speed

Alphaflo ECO-V 100 is also equipped with an energy-saving variable speed motor that offers the finest adjustment in operating speed with 25 RPM increments, allowing fine-tuning of the pump's motor speed to perfectly match the flow requirements of the swimming pool, maximising energy savings and minimising pump noise.

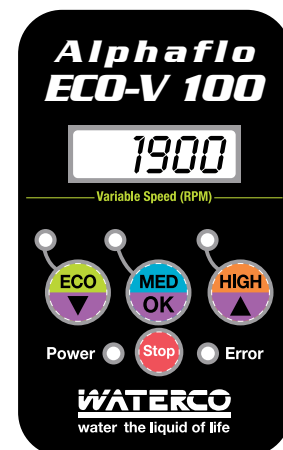

**PERFECTLY MATCH  
FLOW REQUIREMENTS  
AND MAXIMISE ENERGY  
SAVINGS.**

# SAVE HUNDREDS OF DOLLARS OFF YOUR ENERGY BILLS.

## Ultra Quiet

Alphaflo ECO-V 100 operates most economically and with the lowest noise level at its low speed setting. Its low speed setting significantly reduces the pump's vibration, motor noise and water turbulence to an ultra low 57 decibels (dBA).

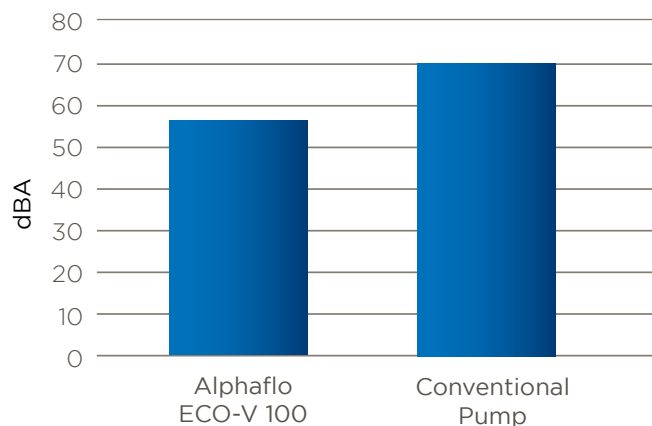

## Off-Peak Operation

Its low noise levels enable it to be operated at times that are not allowable for conventional pool pumps. An Alphaflo ECO-V 100 allows you to take advantage of off-peak electrical tariff periods, without upsetting your neighbours.

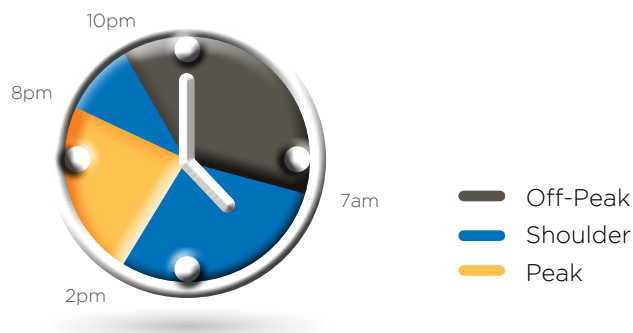

# ENHANCE WATER CLARITY

## Benefit of Slow Flow

Lowering a pumps flow rate not only significantly decreases the pump's energy requirements, but also reduces water flow resistance in your pool equipment and plumbing. Even though you may need to operate the Alphaflo ECO-V 100 longer, it is far more efficient pumping low water flow compared to high water flow.

A slow flow rate also has the added benefit of improving your pool's filtration efficiency, enhancing the clarity of your swimming pool water. Plus your automatic chemical dosers and salt chlorinators are also more effective when the pool water is circulated longer.



# KEY FEATURES

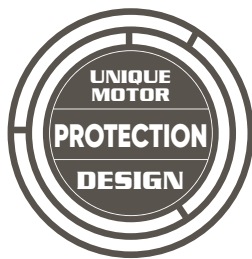

The Alphaflo pump has a unique design that stops water from leaking into the motor through the drive shaft.

A mechanical seal may leak water if the pump is ever run dry or simply be worn out. If a leaky mechanical seal is not replaced promptly, water will travel up the shaft of the motor and ruin the motor in a very short period of time.

Waterco's unique Alphaflo design protects the pump motor's end shield from any water contact, by allowing any leaks through worn-out mechanical seals by draining out of the pump.

Variable 3 speed control panel, IPX5 rating

Permanent magnet brushless Variable 3 speed DC motor

UV stabilised & corrosion resistant

50mm quick connect barrel unions for UPVC pipe

Clear basket lid & large 2.05 litre strainer basket

High grade carbon / graphite mechanical seal with 316 stainless steel spring assembly

Strong single piece glass filled thermoplastic pump body

Drain plugs

Stable & insulated support base

Hydraulically efficient single-piece diffuser/nozzle design impeller

Fan cooled thermal overload protection

## Alphaflo ECO-V 100 Performance Curves

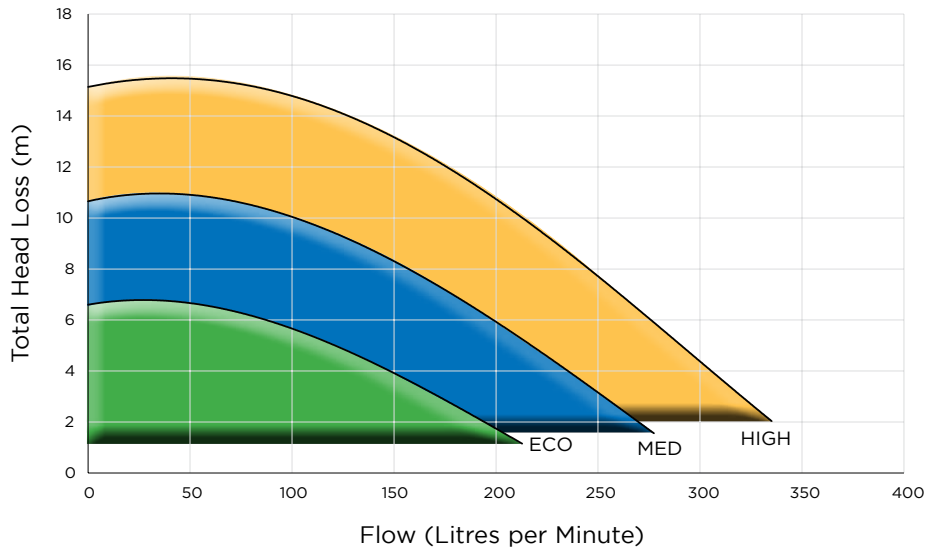

## Alphaflo ECO-V 100 Noise Levels

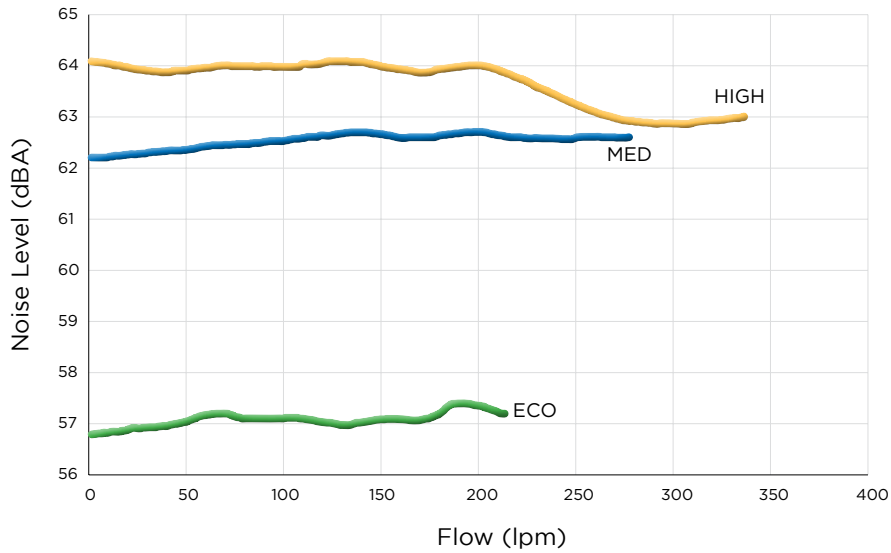

- ECO speed (1900rpm)
- Medium speed (2410rpm)
- High speed (2850rpm)

## Warranty

Pumps	3 years (conditional)*
Wet End	3 years
Motor, mechanical seal, hair & lint pot lid, o'ring, basket, impeller & diffuser	2 years
Commercial applications	1 year
Labour	1 year

\*Please refer to Waterco's warranty terms and conditions



## Specifications

Length (mm)	Height (mm)	Width (mm)	Packaged Weight (kg)	Inlet/Outlet (mm)	Strainer Basket (lt)
657	343	253	14	50	2.05

### ECO speed (1900rpm)

Pump Total Head (m)	Flow Rate (lpm)	Motor Input (kW)	Amps	Noise Level (dBA)
4.2	148	0.30	2.1	65.7
5.0	127	0.29	2.1	65.5
5.8	106	0.29	2.0	65.5

### Medium speed (2410rpm)

Pump Total Head (m)	Flow Rate (lpm)	Motor Input (kW)	Amps	Noise Level (dBA)
4.9	221	0.55	3.7	68.7
6.4	193	0.55	3.7	68.7
9.1	138	0.53	3.6	68.9

### High speed (2850rpm)

Pump Total Head (m)	Flow Rate (lpm)	Motor Input (kW)	Amps	Noise Level (dBA)
6.8	263	0.90	5.9	70.6
11.1	197	0.89	5.9	70.6
14.2	132	0.82	5.5	70.6

## Dimensions (mm)

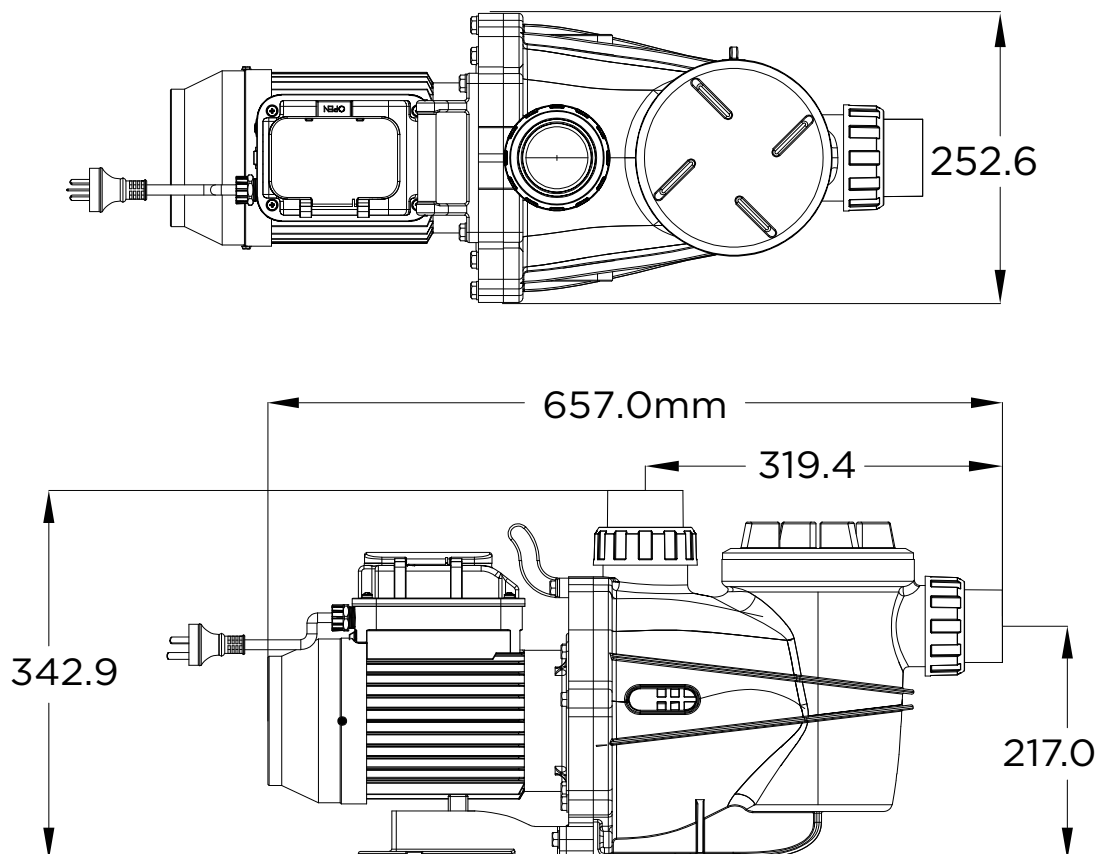

**OFFICES - AUSTRALIA**

**NSW - Sydney (Head Office)**

Tel: +61 2 9898 8686

**QLD - Brisbane**

Tel: +61 7 3299 9900

**VIC/TAS - Melbourne**

Tel: +61 3 9764 1211

**WA - Perth**

Tel: +61 8 9273 1900

**SA/NT - Adelaide**

Tel: +61 8 8244 6000

**ACT Distribution**

Tel: +61 2 6280 6476

**OFFICES - OVERSEAS**

**Waterco (Europe) Limited**

Sittingbourne, Kent, UK  
Tel: +44 (0) 1795 521 733

**Waterco (USA) Inc**

Augusta, Georgia, USA  
Tel: +1 706 793 7291

**Waterco Canada**

Boucherville, Qc, Canada  
Tel: +1 450 748 1421

**Waterco (NZ) Limited**

Auckland, New Zealand  
Tel: +64 9 525 7570

**Waterco (C) Limited**

Guangzhou, China  
Tel: +86 20 3222 2180

**PT Waterco Indonesia**

Jakarta, Indonesia  
Tel: +62 21 4585 1481

**Waterco Singapore Intl Pte Ltd**

MAPEX Building, Singapore  
Tel: +65 6344 2378

**Waterco (Far East) Sdn Bhd**

Selangor, Malaysia  
Tel: +60 3 6145 6000

**Waterco Vietnam Company Limited**

Ho Chi Minh City, Vietnam  
Tel: +84 28 3622 7780

Distributed by:



In the interest of providing better quality and value we are constantly improving and updating our products. Consequently, pictures and information on our brochures may sometimes vary slightly from models available.

ZZB2094 10/23